



EASTLIKE LED Co., Ltd

CATALOG

LED Lighting Series

Green Low Carbon Energy Saving

3. Panel Light

2022

www.eastlike.com

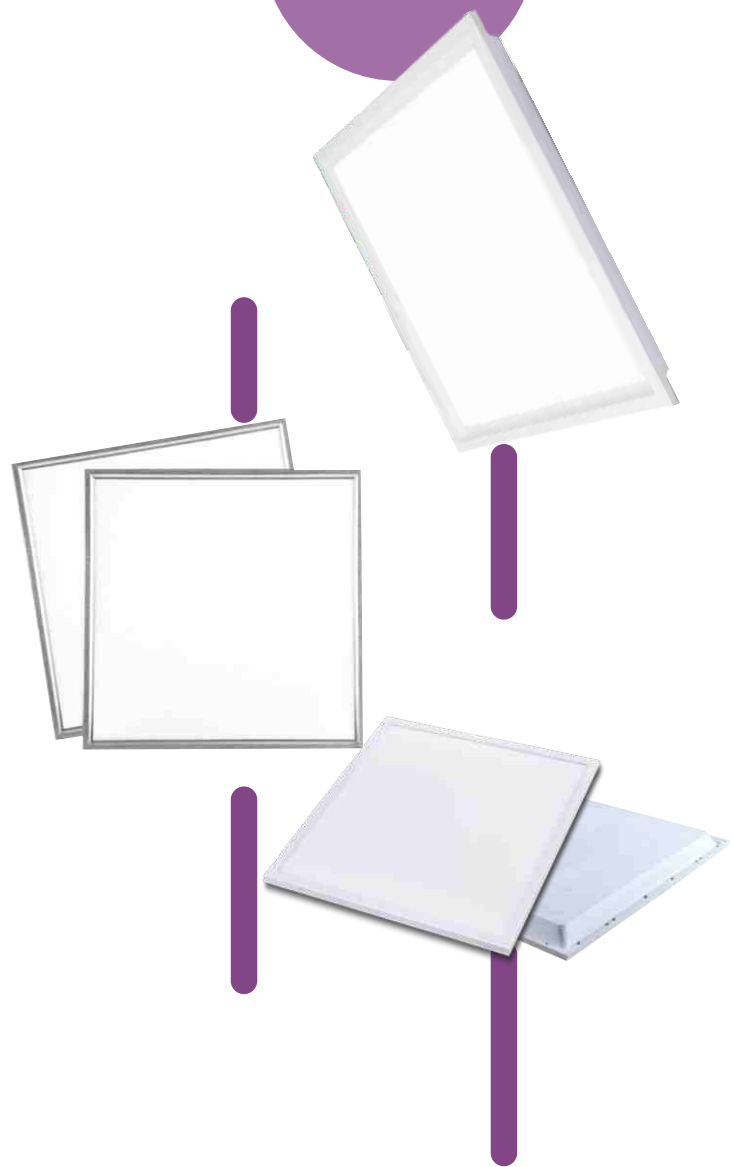



公司簡介 Company Profile



製造和營銷綠色低碳節能照明產品
Manufacturing And Marketing Green Low Carbon
And Energy Saving Lighting Products

EASTLIKE LED COMPANY 東 欏 照 明 公 司

EASTLIKE LED Co., Ltd • emerges as a lighting designer manufacturer and supplier established in Hong Kong and Mainland China .

The company devotes herself in the development, manufacturing and marketing of green, low-carbon and energy-saving lighting products. we are proud to provide a wide range of LED products

東欏LED照明公司•您的照明設計師。

我們作為製造商和供應服務於香港和中國大陸。公司致力於開發，製造和行銷綠色，低碳和節能照明產品。

我們竭誠為您服務，為您提供種類繁多的LED產品。

目录

Content

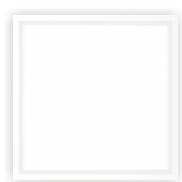

P.01
LED平板燈

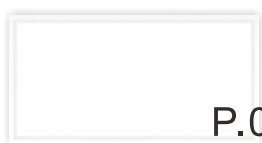

P.02
LED平板燈



P.03
平板燈

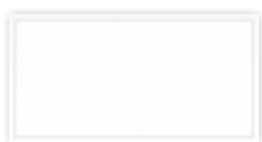

P.04
平板燈



P.05
led集成側發光吊頂面板燈



P.06
led集成側發光吊頂面板燈



P.07
側發光吊頂面板燈



P.08
側發光吊頂面板燈

LED Panel Light

Series Type: EPLPN11

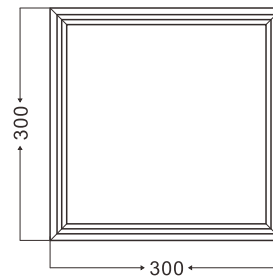

(Unit : mm)

Features 產品特點

- ★ New direct light emitting technology, no video flash design
- ★ The new lens does not turn yellow
- ★ Long service life and lasting brightness
- ★ Specially designed for ceiling, suitable for all kinds of commercial lighting
- ★ Ceiling installation (equipped with hardware hook and triangle)

- ★ 新型直發光技術，無可視頻閃設計
- ★ 新型透鏡不發黃
- ★ 壽命長，亮度持久
- ★ 專為吊頂設計，適合各種商業照明
- ★ 吊頂安裝(配五金掛鉤三角掛)

Specification 產品規格

Model 型號	Voltage 電壓	Power 功率	Lumen Output 輸出流明	Color Rendering 顯色度	Colour Temp 色溫	Life Time 壽命	Beam Angle 光束角	Working temperature 工作溫度	Size 尺寸
	(V)	(W)	(Lm/W)	(CRI)	(K)	(H)	(°)	(°C)	(mm)
EPL-PN3030-T	100-240	20	100	>80	6000	30,000	180	-20~45	300*300*35

Light efficiency (lm/W), Power (W), Color Rendering Index (CRI), Can be customized according to customer needs.

Our Standard Power factor (PF) > 0.9 and Total harmonic index THD < 15%, According to customer requirements can produce a lower THD < 10%.

This type of certification is issued by a government-approved laboratory for Safety certification, Fire testing, Restriction of Hazardous Substances (RoHS), Photobiological safety of lamps and lamp systems. (an Exemption Group) and other test certifications to ensure product quality

光效 (lm/W)、功率 (W)、顯色指數 (CRI)，可根據客戶需求定制。

此型號標準之功率因素 (PF) > 0.9，總諧波指數 THD < 15%，可按客戶需要生產低總諧波指數 < 10%。

此型號認證由可實驗室發出之安全認證消防測試，環保物料 (RoHS)，光生物安全為 Exemption Group 及其它測試，保證客戶使用更安心滿意。

LED Panel Light

Series Type: EPLPN12

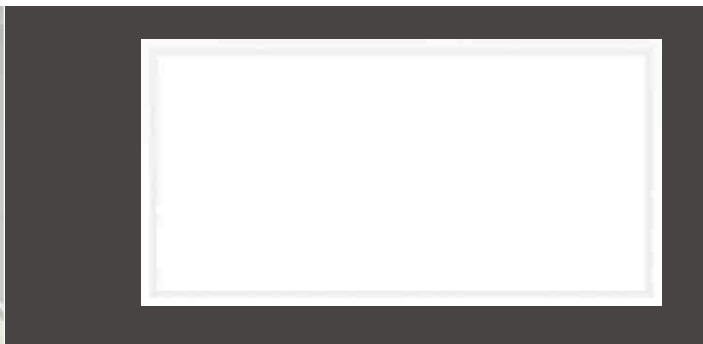

(Unit : mm)

Features 產品特點

- ★ New direct light emitting technology, no video flash design
- ★ The new lens does not turn yellow
- ★ Long service life and lasting brightness
- ★ Specially designed for ceiling, suitable for all kinds of commercial lighting
- ★ Ceiling installation (equipped with hardware hook and triangle)

- ★ 新型直發光技術，無可視頻閃設計
- ★ 新型透鏡 不發黃
- ★ 壽命長，亮度持久
- ★ 專為吊頂設計，適合各種商業照明
- ★ 吊頂安裝(配五金掛鉤三角掛)

Specification 產品規格

Model 型號	Voltage 電壓	Power 功率	Lumen Output 輸出流明	Color Rendering 顯色度	Colour Temp 色溫	Life Time 壽命	Beam Angle 光束角	Working temperature 工作溫度	Size 尺寸
	(V)	(W)	(Lm/W)	(CRI)	(K)	(H)	(°)	(°C)	(mm)
EPL-PN3060-T	100-240	40	100	>80	6000	30,000	180	-20~45	300*600*35

Light efficiency (lm/W), Power (W), Color Rendering Index (CRI), Can be customized according to customer needs.

Our Standard Power factor (PF) > 0.9 and Total harmonic index THD < 15%, According to customer requirements can produce a lower THD < 10%.

This type of certification is issued by a government-approved laboratory for Safety certification, Fire testing, Restriction of Hazardous Substances (RoHS), Photobiological safety of lamps and lamp systems. (an Exemption Group) and other test certifications to ensure product quality

光效 (lm/W)、功率 (W)、顯色指數 (CRI)，可根據客戶需求定制。

此型號標準之功率因素 (PF) > 0.9，總諧波指數 THD < 15%，可按客戶需要生產低總諧波指數 < 10%。

此型號認證由可實驗室發出之安全認證消防測試，環保物料 (RoHS)，光生物安全為 Exemption Group 及其它測試，保證客戶使用更安心滿意。

Panel Light

Series Type: EPLPN22

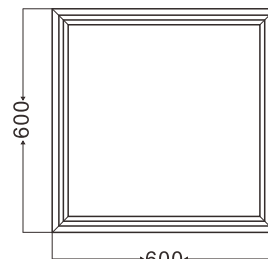
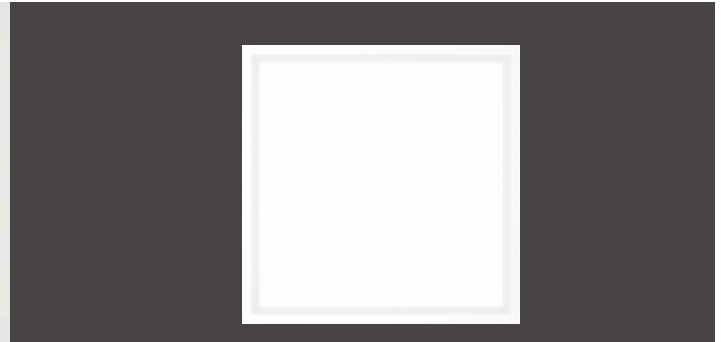

(Unit : mm)

Features 產品特點

- ★ New direct light emitting technology, no video flash design
- ★ The new lens does not turn yellow
- ★ Long service life and lasting brightness
- ★ Specially designed for ceiling, suitable for all kinds of commercial lighting
- ★ Ceiling installation (equipped with hardware hook and triangle)

- ★ 新型直發光技術，無可視頻閃設計
- ★ 新型透鏡不發黃
- ★ 壽命長，亮度持久
- ★ 專為吊頂設計，適合各種商業照明
- ★ 吊頂安裝(配五金掛鉤三角掛)

Specification 產品規格

Model 型號	Voltage 電壓	Power 功率	Lumen Output 輸出流明	Color Rendering 顯色度	Colour Temp 色溫	Life Time 壽命	Beam Angle 光束角	Working temperature 工作溫度	Size 尺寸
	(V)	(W)	(Lm/W)	(CRI)	(K)	(H)	(°)	(°C)	(mm)
EPL-PN6060-T	100-240	32	100	>80	4000	30,000	180	-20~45	600*600*35

Light efficiency (lm/W), Power (W), Color Rendering Index (CRI), Can be customized according to customer needs.

Our Standard Power factor (PF) > 0.9 and Total harmonic index THD < 15%, According to customer requirements can produce a lower THD < 10%.

This type of certification is issued by a government-approved laboratory for Safety certification, Fire testing, Restriction of Hazardous Substances (RoHS), Photobiological safety of lamps and lamp systems. (an Exemption Group) and other test certifications to ensure product quality

光效 (lm/W)、功率 (W)、顯色指數 (CRI)，可根據客戶需求定制。

此型號標準之功率因素 (PF) > 0.9，總諧波指數 THD < 15%，可按客戶需要生產低總諧波指數 < 10%。

此型號認證由可實驗室發出之安全認證消防測試，環保物料 (RoHS)，光生物安全為 Exemption Group 及其它測試，保證客戶使用更安心滿意。

Panel Light

Series Type: EPLPN24

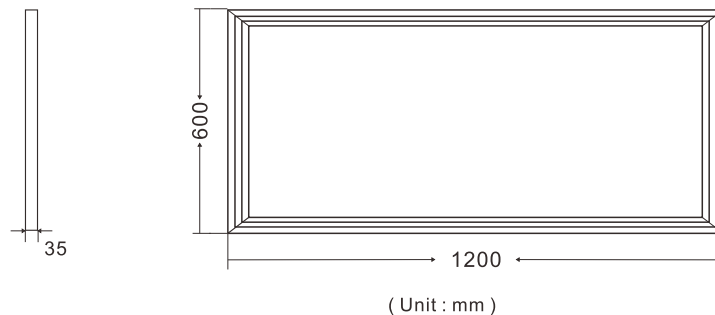

Features 產品特點

- ★ New direct light emitting technology, no video flash design
 - ★ The new lens does not turn yellow
 - ★ Long service life and lasting brightness
 - ★ Specially designed for ceiling, suitable for all kinds of commercial lighting
 - ★ Ceiling installation (equipped with hardware hook and triangle)
- ★ 新型直發光技術，無可視頻閃設計
 - ★ 新型透鏡 不發黃
 - ★ 壽命長，亮度持久
 - ★ 專為吊頂設計，適合各種商業照明
 - ★ 吊頂安裝(配五金掛鉤三角掛)

Specification 產品規格

Model 型號	Voltage 電壓	Power 功率	Lumen Output 輸出流明	Color Rendering 顯色度	Colour Temp 色溫	Life Time 壽命	Beam Angle 光束角	Working temperature 工作溫度	Size 尺寸
	(V)	(W)	(Lm/W)	(CRI)	(K)	(H)	(°)	(°C)	(mm)
EPL-PN60120-T	100-240	70	100	>80	4000	30,000	180	-20~45	600*1200*35

Light efficiency (lm/W), Power (W), Color Rendering Index (CRI), Can be customized according to customer needs.
 Our Standard Power factor (PF) > 0.9 and Total harmonic index THD < 15%, According to customer requirements can produce a lower THD < 10%.
 This type of certification is issued by a government-approved laboratory for Safety certification, Fire testing, Restriction of Hazardous Substances (RoHS), Photobiological safety of lamps and lamp systems. (an Exemption Group) and other test certifications to ensure product quality

光效 (lm/W)、功率 (W)、顯色指數 (CRI)，可根據客戶需求定制。
 此型號標準之功率因素 (PF) > 0.9，總諧波指數 THD < 15%，可按客戶需要生產低總諧波指數 < 10%。
 此型號認證由可實驗室發出之安全認證消防測試，環保物料 (RoHS)，光生物安全為 Exemption Group 及其它測試，保證客戶使用更安心滿意。

LED Integrated Side Luminous Ceiling Panel Lamp

Series Type: EPLAP11

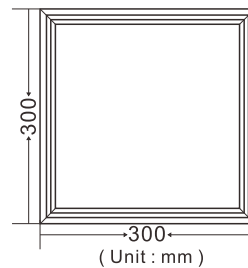
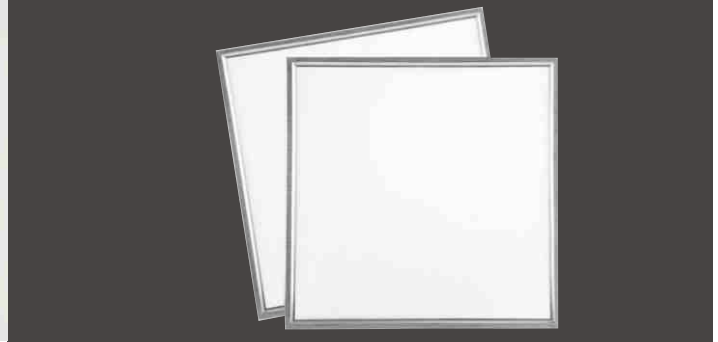

Features 產品特點

- ★ Oxidation heat dissipation aluminum material is corrosion-resistant and durable
- ★ The light is soft and does not hurt the eyes
- ★ Metal shell waterproof power supply and efficient heat dissipation
- ★ Ceiling installation (equipped with hardware hook and triangle)
- ★ 氧化散熱鋁材抗腐蝕耐用
- ★ 光線柔和不傷眼
- ★ 金屬外殼防水電源 高效散熱
- ★ 吊頂安裝(配五金掛鉤三角掛)

Specification 產品規格

Model 型號	Voltage 電壓 (V)	Power 功率 (W)	Lumen Output 輸出流明 (Lm/W)	Color Rendering 顯色度 (CRI)	Colour Temp 色溫 (K)	Life Time 壽命 (H)	Beam Angle 光束角 (°)	Working temperature 工作溫度 (°C)	Size 尺寸 (mm)
EPL-PN3030-N88A4	100-240	12	80	>80	4000	30,000	180	-20~45	300*300*10
EPL-PN3030-N88A6	100-240	12	80	>80	6000	30,000	180	-20~45	300*300*10

Light efficiency (lm/W), Power (W), Color Rendering Index (CRI), Can be customized according to customer needs.

Our Standard Power factor (PF) > 0.9 and Total harmonic index THD < 15%, According to customer requirements can produce a lower THD < 10%.

This type of certification is issued by a government-approved laboratory for Safety certification, Fire testing, Restriction of Hazardous Substances (RoHS), Photobiological safety of lamps and lamp systems. (an Exemption Group) and other test certifications to ensure product quality

光效 (lm/W)、功率 (W)、顯色指數 (CRI)，可根據客戶需求定制。

此型號標準之功率因素 (PF) > 0.9，總諧波指數 THD < 15%，可按客戶需要生產低總諧波指數 < 10%。

此型號認證由可實驗室發出之安全認證消防測試，環保物料 (RoHS)，光生物安全為 Exemption Group 及其它測試，保證客戶使用更安心滿意。

LED Integrated Side Luminous Ceiling Panel Lamp

Series Type: EPLAP12

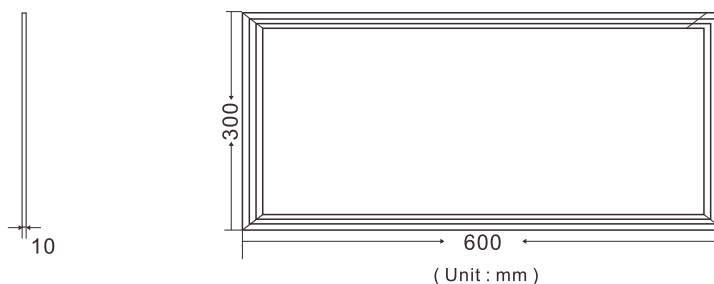
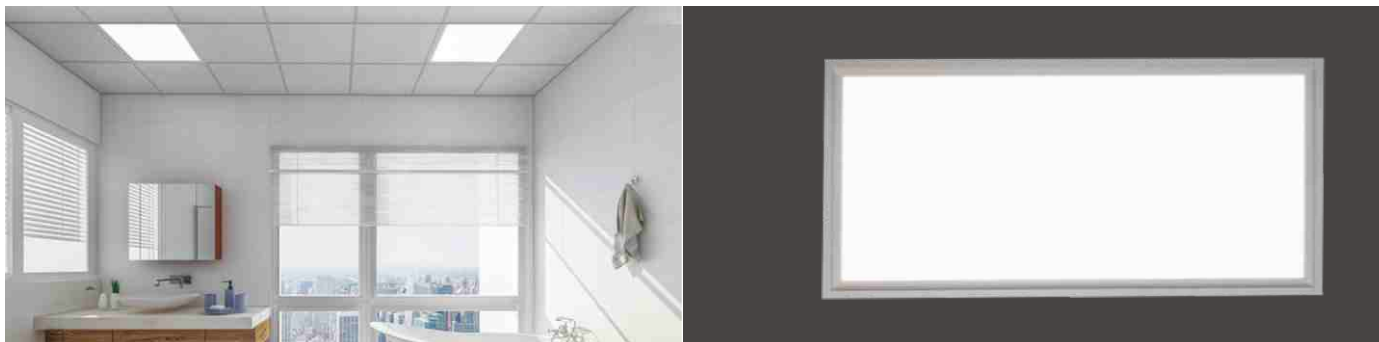

Features 產品特點

- ★ Oxidation heat dissipation aluminum material is corrosion-resistant and durable
- ★ The light is soft and does not hurt the eyes
- ★ Metal shell waterproof power supply and efficient heat dissipation
- ★ Ceiling installation (equipped with hardware hook and triangle)
- ★ 氧化散熱鋁材抗腐蝕耐用
- ★ 光線柔和不傷眼
- ★ 金屬外殼防水電源 高效散熱
- ★ 吊頂安裝(配五金掛鉤三角掛)

Specification 產品規格

Model 型號	Voltage 電壓	Power 功率	Lumen Output 輸出流明	Color Rendering 顯色度	Colour Temp 色溫	Life Time 壽命	Beam Angle 光束角	Working temperature 工作溫度	Size 尺寸
	(V)	(W)	(Lm/W)	(CRI)	(K)	(H)	(°)	(°C)	(mm)
EPL-PN3060-N88A4	100-240	24	80	>80	4000	30,000	180	-20~45	300*600*10
EPL-PN3060-N88A6	100-240	24	80	>80	6000	30,000	180	-20~45	300*600*10

Light efficiency (lm/W), Power (W), Color Rendering Index (CRI), Can be customized according to customer needs.

Our Standard Power factor (PF) > 0.9 and Total harmonic index THD < 15%, According to customer requirements can produce a lower THD < 10%.

This type of certification is issued by a government-approved laboratory for Safety certification, Fire testing, Restriction of Hazardous Substances (RoHS), Photobiological safety of lamps and lamp systems. (an Exemption Group) and other test certifications to ensure product quality

光效 (lm/W)、功率 (W)、顯色指數 (CRI)，可根據客戶需求定制。

此型號標準之功率因素 (PF) > 0.9，總諧波指數 THD < 15%，可按客戶需要生產低總諧波指數 < 10%。

此型號認證由可實驗室發出之安全認證消防測試，環保物料 (RoHS)，光生物安全為 Exemption Group 及其它測試，保證客戶使用更安心滿意。

Side Light Ceiling Panel Lamp

Series Type: EPLAP22

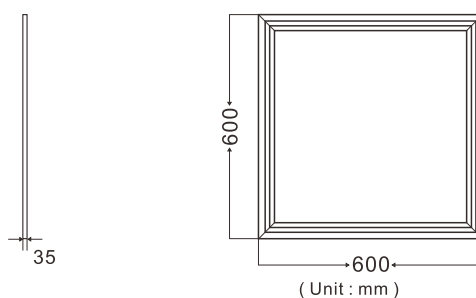
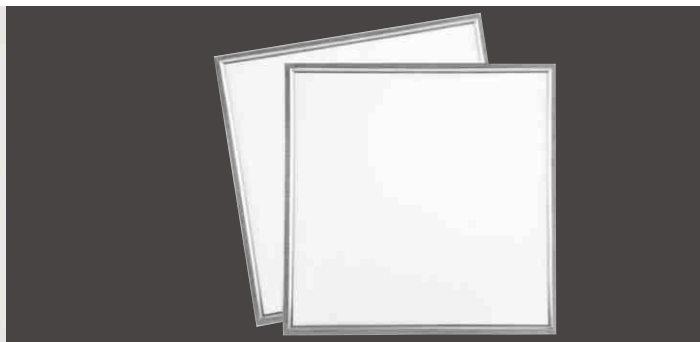

Features 產品特點

- ★ Oxidation heat dissipation aluminum material is corrosion-resistant and durable
- ★ The light is soft and does not hurt the eyes
- ★ Metal shell waterproof power supply and efficient heat dissipation
- ★ Ceiling installation (equipped with hardware hook and triangle)
- ★ 氧化散熱鋁材抗腐蝕耐用
- ★ 光線柔和不傷眼
- ★ 金屬外殼防水電源 高效散熱
- ★ 吊頂安裝(配五金掛鉤三角掛)

Specification 產品規格

Model 型號	Voltage 電壓 (V)	Power 功率 (W)	Lumen Output 輸出流明 (Lm/W)	Color Rendering 顯色度 (CRI)	Colour Temp 色溫 (K)	Life Time 壽命 (H)	Beam Angle 光束角 (°)	Working temperature 工作溫度 (°C)	Size 尺寸 (mm)
EPL-PN6060-N	100-240	36	100	>80	4000	30,000	180	-20~45	600*600*35

Light efficiency (lm/W), Power (W), Color Rendering Index (CRI), Can be customized according to customer needs.

Our Standard Power factor (PF) > 0.9 and Total harmonic index THD < 15%, According to customer requirements can produce a lower THD < 10%.

This type of certification is issued by a government-approved laboratory for Safety certification, Fire testing, Restriction of Hazardous Substances (RoHS), Photobiological safety of lamps and lamp systems. (an Exemption Group) and other test certifications to ensure product quality

光效 (lm/W)、功率 (W)、顯色指數 (CRI)，可根據客戶需求定制。

此型號標準之功率因素 (PF) > 0.9，總諧波指數 THD < 15%，可按客戶需要生產低總諧波指數 < 10%。

此型號認證由可實驗室發出之安全認證消防測試，環保物料 (RoHS)，光生物安全為 Exemption Group 及其它測試，保證客戶使用更安心滿意。

Side Light Ceiling Panel Lamp

Series Type: EPLAP24

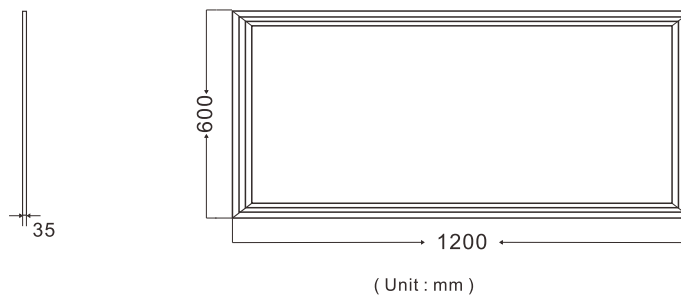

Features 產品特點

- ★ Oxidation heat dissipation aluminum material is corrosion-resistant and durable
- ★ The light is soft and does not hurt the eyes
- ★ Metal shell waterproof power supply and efficient heat dissipation
- ★ Ceiling installation (equipped with hardware hook and triangle)
- ★ 氧化散熱鋁材抗腐蝕耐用
- ★ 光線柔和不傷眼
- ★ 金屬外殼防水電源 高效散熱
- ★ 吊頂安裝(配五金掛鉤三角掛)

Specification 產品規格

Model 型號	Voltage 電壓	Power 功率	Lumen Output 輸出流明	Color Rendering 顯色度	Colour Temp 色溫	Life Time 壽命	Beam Angle 光束角	Working temperature 工作溫度	Size 尺寸
	(V)	(W)	(Lm/W)	(CRI)	(K)	(H)	(°)	(°C)	(mm)
EPL-PN60120-N	100-240	72	100	>80	6000	30,000	180	-20~45	600*1200*35

Light efficiency (lm/W), Power (W), Color Rendering Index (CRI), Can be customized according to customer needs.

Our Standard Power factor (PF) > 0.9 and Total harmonic index THD < 15%, According to customer requirements can produce a lower THD < 10%.

This type of certification is issued by a government-approved laboratory for Safety certification, Fire testing, Restriction of Hazardous Substances (RoHS), Photobiological safety of lamps and lamp systems. (an Exemption Group) and other test certifications to ensure product quality

光效 (lm/W)、功率 (W)、顯色指數 (CRI)，可根據客戶需求定制。

此型號標準之功率因素 (PF) > 0.9，總諧波指數 THD < 15%，可按客戶需要生產低總諧波指數 < 10%。

此型號認證由可實驗室發出之安全認證消防測試，環保物料 (RoHS)，光生物安全為 Exemption Group 及其它測試，保證客戶使用更安心滿意。

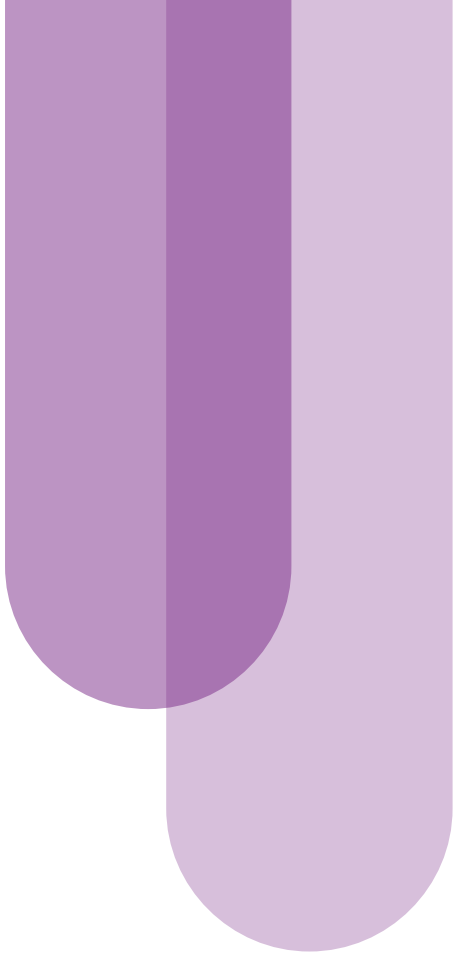

東 權 LED 照 明 公 司
EASTLIKE LED Co., Ltd

Office Address: Room B3, 18/F Bonsun Industrial Building,
364-366 Sha Tsui Road, Tsuen Wan, HongKong

Phone: 852-3974 5593

Fax: 852-3544 0462

Whatsapp: +852-6756 770

Email: info@eastlike.com